

Series CSR

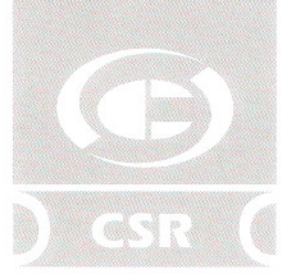

Solid Electrolytic Tantalum Chip Capacitors Surface Mount Low ESR Type



Brief Introduction

The CSR Series is low ESR tantalum chip capacitor, suitable for SMD electric board used for telecommunication, computers, camcorder and mobile phone set and so on. Low ESR values conform with EIA535BAAC sizes. CSR Series is equivalent to KEMET T494 Series

SPECIFICATION:

Item	Performance Characteristics																																															
Operating Temperature Range	-55 to + 125°C (>85°C with rated voltage derating)																																															
Rated Working Voltage Range	4 to 50 V DC																																															
Nominal Capacitance Range	0.1 to 470 μF																																															
Capacitance Tolerance	±20% ± 10% (120Hz, +20°C)																																															
Leakage Current	Not more than 0.01CV [μA] or 0.5μA whichever is greater																																															
tan δ (120Hz, +20°C)	0.04 max. for ≤ 1.0μF																																															
	0.06 max. for 1.5 to 68μF																																															
	0.08 max. for 100 to 470 μF																																															
Characteristics at High and Low Temperature	-55°C	Capacitance change	±12% of initial measured value at +20°C																																													
	+105°C	Leakage current	≤12.5% of initial measured value																																													
		Capacitance change	±15% of initial measured value at +20°C																																													
Moisture Resistance	Test conditions																																															
	Relative humidity : 90 to 95% without load Ambient temperature : +40°C Duration : 500 hours Post test requirements at + 20°C Leakage current : ≤ Initial specified value Capacitance change : ± 10% of initial measured value tan δ : ≤ Initial specified value																																															
Endurance	Test conditions																																															
	<table border="1"> <thead> <tr> <th>Item \ Conditions</th> <th colspan="4">Derating</th> <th colspan="4">Rating</th> </tr> </thead> <tbody> <tr> <td>Duration</td> <td colspan="4">1000 hours</td> <td colspan="4">1000 hours</td> </tr> <tr> <td>Ambient temperature</td> <td colspan="4">+ 105°C</td> <td colspan="4">+ 85°C</td> </tr> <tr> <td>Applied voltage</td> <td colspan="4">Derated working voltage</td> <td colspan="4">Rated working voltage</td> </tr> <tr> <td>Source impedance</td> <td colspan="4">1Ω/V</td> <td colspan="4">1Ω/V</td> </tr> </tbody> </table>			Item \ Conditions	Derating				Rating				Duration	1000 hours				1000 hours				Ambient temperature	+ 105°C				+ 85°C				Applied voltage	Derated working voltage				Rated working voltage				Source impedance	1Ω/V				1Ω/V			
	Item \ Conditions	Derating				Rating																																										
	Duration	1000 hours				1000 hours																																										
	Ambient temperature	+ 105°C				+ 85°C																																										
	Applied voltage	Derated working voltage				Rated working voltage																																										
	Source impedance	1Ω/V				1Ω/V																																										
	Derating voltage + 105°C																																															
	<table border="1"> <tbody> <tr> <td>Working voltage [V] DC</td> <td>4</td> <td>6.3</td> <td>10</td> <td>16</td> <td>20</td> <td>25</td> <td>35</td> <td>50</td> </tr> <tr> <td>Derating voltage [V] DC</td> <td>2.5</td> <td>4</td> <td>6.3</td> <td>10</td> <td>13</td> <td>16</td> <td>22</td> <td>32</td> </tr> </tbody> </table>			Working voltage [V] DC	4	6.3	10	16	20	25	35	50	Derating voltage [V] DC	2.5	4	6.3	10	13	16	22	32																											
	Working voltage [V] DC	4	6.3	10	16	20	25	35	50																																							
Derating voltage [V] DC	2.5	4	6.3	10	13	16	22	32																																								
Post test requirements at +20°C																																																
Leakage current : ≤ 125% of initial specified value																																																
Capacitance change : ± 10% of initial measured value																																																
tan δ : ≤ Initial specified value																																																
Shelf Life	Test conditions																																															
	Duration : 1000 hours																																															
	Ambient temperature : +105°C																																															
	Applied voltage : (none)																																															
Solder Heat Resistance	The capacitor shall withstand dipping into solder bath for 5±1 seconds at 260±5°C																																															
	Post test requirements at +20°C Same limits for "Endurance".																																															

Series CSR

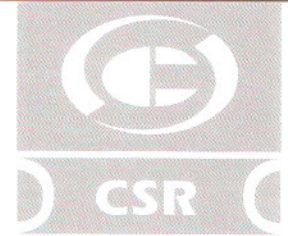

Solid Electrolytic Tantalum Chip Capacitors Surface Mount Low ESR Type

1. Tantalum Capacitor CHIP Type Outline Drawings.

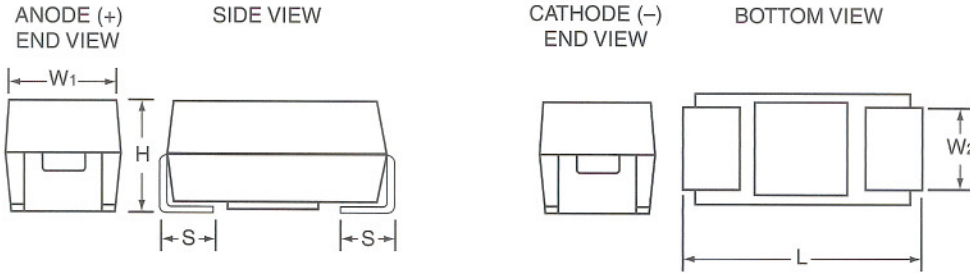

2. Dimensions Millimeters (Inch)

Case Size	L±0.2 (0.008)	W1±0.2 (0.008)	H±0.2 (0.008)	S±0.2 (0.008)	W2±0.2 (0.008)
S	2.0 (0.079)	1.2 (0.047)	1.2 (0.047)	0.5 (0.020)	1.2 (0.047)
A	3.2 (0.126)	1.6 (0.063)	1.6 (0.063)	0.8 (0.031)	1.2 (0.047)
B	3.5 (0.137)	2.8 (0.110)	1.9 (0.075)	0.8 (0.031)	2.2 (0.087)
C	6.0 (0.236)	3.2 (0.126)	2.5 (0.098)	1.3 (0.051)	2.2 (0.087)
D	7.3 (0.287)	4.3 (0.169)	2.8 (0.110)	1.3 (0.051)	2.4 (0.094)
E	7.3 (0.287)	4.3 (0.169)	4.0 (0.157)	1.3 (0.051)	2.4 (0.094)

3. Rated Voltage, Capacitance of Capacitors.

Rated Voltage (V)	4	6.3	10	16	20	25	35	50
Code	0G	0J	1A	1C	1D	1E	1V	1H
Capacitance (µF)	Case Size							
0.10 (104)							A	A
0.15 (154)							A	A/B
0.22 (224)							A	B
0.33 (334)						A	A	B
0.47 (474)						A	A/B	B/C
0.68 (684)					A	A	A/B	B/C
1.0 (105)				A	A	A/B	A/B	C
1.5 (155)			A	A	A	A/B	B/C	C/D
2.2 (225)		A	A	S/A	A/B	B/C	B/C	C/D
3.3 (335)	A	A	A	A/B	A/B	B/C	B/C	D
4.7 (475)	A	A	S/A/B	A/B	A/B/C	B/C	C/D	D
6.8 (685)	A	S/A/B	A/B	A/B/C	B/C	C	C/D	E
10 (106)	S/A/B	S/A/B	A/B/C	B/C	B/C	C/D	C/D	
15 (156)	A/B	A/B/C	A/B/C	B/C	C/D	C/D	D/E	
22 (226)	A/B/C	A/B/C	B/C	C/D	C/D	D	D/E	
33 (336)	A/B/C	A/B/C	B/C/D	C/D	C/D	D/E		
47 (476)	A/B/C	B/C/D	C/D	C/D	D	E		
68 (686)	B/C/D	C/D	C/D	D	D/E			
100 (107)	B/C/D	C/D	C/D	D/E	E			
150 (157)	C/D	C/D	D/E	E				
220 (227)	D	D/E	D/E					
330 (337)	D	D/E	E					
470 (477)	D/E	E						

Series CSR

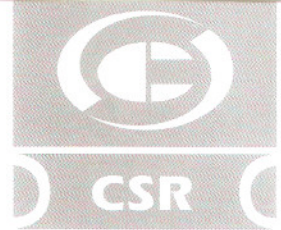

Solid Electrolytic Tantalum Chip Capacitors Surface Mount Low ESR Type

Ratings and Part Number Reference

Part No.	Case Size	Capacitance μF	DCL (μA) Max.	DF % Max.	ESR max. (Ω) @ 100kHz
4 volt @ 85°C (2.5 volt, @125°C)					
CSRA 0G335(#)TR	A	3.3	0.5	6	4.0
CSRA 0G475(#)TR	A	4.7	0.5	6	3.5
CSRA 0G685(#)TR	A	6.8	0.5	6	3.0
CSRS 0G106(#)TR	S	10	0.5	6	6.0
CSRA 0G106(#)TR	A	10	0.5	6	2.0
CSRB 0G106(#)TR	B	10	0.5	6	1.2
CSRA 0G156(#)TR	A	15	0.6	6	1.5
CSRB 0G156(#)TR	B	15	0.6	6	1.2
CSRA 0G226(#)TR	A	22	0.88	6	1.5
CSRB 0G226(#)TR	B	22	0.88	6	0.6
CSRC 0G226(#)TR	C	22	0.88	6	0.5
CSRA 0G336(#)TR	A	33	1.32	6	3.0
CSRB 0G336(#)TR	B	33	1.32	6	0.6
CSRC 0G336(#)TR	C	33	1.32	6	0.5
CSRA 0G476(#)TR	A	47	1.88	6	2.0
CSRB 0G476(#)TR	B	47	1.88	6	0.6
CSRC 0G476(#)TR	C	47	1.88	6	0.5
CSRB 0G686(#)TR	B	68	2.72	6	2.0
CSRC 0G686(#)TR	C	68	2.72	6	0.25
CSRD 0G686(#)TR	D	68	2.72	6	0.2
CSRB 0G107(#)TR	B	100	4.0	8	0.6
CSRC 0G107(#)TR	C	100	4.0	8	0.2
CSRD 0G107(#)TR	D	100	4.0	8	0.2
CSRC 0G157(#)TR	C	150	6.0	8	0.2
CSRD 0G157(#)TR	D	150	6.0	8	0.15
CSRD 0G227(#)TR	D	220	8.8	8	0.15
CSRD 0G337(#)TR	D	330	13.2	8	0.15
CSRD 0G477(#)TR	D	470	18.8	8	0.15
CSRE 0G477(#)TR	E	470	18.8	8	0.15
6.3 volt @ 85°C (4 volt, @125°C)					
CSRA 0J225(#)TR	A	2.2	0.5	6	6.0
CSRA 0J335(#)TR	A	3.3	0.5	6	6.0
CSRA 0J475(#)TR	A	4.7	0.5	6	3.5
CSRS 0J685(#)TR	S	6.8	0.5	6	8.0
CSRA 0J685(#)TR	A	6.8	0.5	6	2.0
CSRB 0J685(#)TR	B	6.8	0.5	6	1.2
CSRS 0J106(#)TR	S	10	0.63	6	6.0
CSRA 0J106(#)TR	A	10	0.63	6	2.0
CSRB 0J106(#)TR	B	10	0.63	6	1.0
CSRA 0J156(#)TR	A	15	0.94	6	2.0
CSRB 0J156(#)TR	B	15	0.94	6	0.7
CSRC 0J156(#)TR	C	15	0.94	6	0.6
CSRA 0J226(#)TR	A	22	1.38	6	2.0
CSRB 0J226(#)TR	B	22	1.38	6	0.6
CSRC 0J226(#)TR	C	22	1.38	6	0.5
CSRA 0J336(#)TR	A	33	2.07	6	2.0
CSRB 0J336(#)TR	B	33	2.07	6	0.6
CSRC 0J336(#)TR	C	33	2.07	6	0.3
CSRB 0J476(#)TR	B	47	2.96	6	2.0
CSRC 0J476(#)TR	C	47	2.96	6	0.25
CSRD 0J476(#)TR	D	47	2.96	6	0.2
CSRC 0J686(#)TR	C	68	4.28	6	0.2
CSRD 0J686(#)TR	D	68	4.28	6	0.2
CSRC 0J107(#)TR	C	100	6.3	8	0.3
CSRD 0J107(#)TR	D	100	6.3	8	0.15
CSRC 0J157(#)TR	C	150	9.45	8	0.15
CSRD 0J157(#)TR	D	150	9.45	8	0.15
CSRD 0J227(#)TR	D	220	13.86	8	0.15
CSRE 0J227(#)TR	E	220	13.86	8	0.15
CSRD 0J337(#)TR	D	330	20.79	8	0.15
CSRE 0J337(#)TR	E	470	29.60	10	0.1

Part No.	Case Size	Capacitance μF	DCL (μA) Max.	DF % Max.	ESR max. (Ω) @ 100kHz
10 volt @ 85°C (6.3 volt, @125°C)					
CSRA 1A155(#)TR	A	1.5	0.5	6	6.0
CSRA 1A225(#)TR	A	2.2	0.5	6	6.0
CSRA 1A335(#)TR	A	3.3	0.5	6	4.0
CSRS 1A475(#)TR	S	4.7	0.5	6	8.0
CSRA 1A475(#)TR	A	4.7	0.5	6	3.0
CSRB 1A475(#)TR	B	4.7	0.5	6	1.5
CSRA 1A685(#)TR	A	6.8	0.68	6	3.0
CSRB 1A685(#)TR	B	6.8	0.68	6	1.2
CSRA 1A106(#)TR	A	10	1.0	6	2.0
CSRB 1A106(#)TR	B	10	1.0	6	0.8
CSRC 1A106(#)TR	C	10	1.0	6	0.6
CSRA 1A156(#)TR	A	15	1.5	6	4.0
CSRB 1A156(#)TR	B	15	1.5	6	0.7
CSRC 1A156(#)TR	C	15	1.5	6	0.5
CSRB 1A226(#)TR	B	22	2.2	6	0.7
CSRC 1A226(#)TR	C	22	2.2	6	0.4
CSRB 1A336(#)TR	B	33	3.3	6	2.0
CSRC 1A336(#)TR	C	33	3.3	6	0.3
CSRD 1A336(#)TR	D	33	3.3	6	0.25
CSRC 1A476(#)TR	C	47	4.7	6	0.3
CSRD 1A476(#)TR	D	47	4.7	6	0.22
CSRC 1A686(#)TR	C	68	6.8	6	0.3
CSRD 1A686(#)TR	D	68	6.8	6	0.2
CSRC 1A107(#)TR	C	100	10.0	6	0.3
CSRD 1A107(#)TR	D	100	10.0	6	0.15
CSRD 1A157(#)TR	D	150	15	8	0.15
CSRE 1A157(#)TR	E	150	15	8	0.15
CSRD 1A227(#)TR	D	220	22	8	0.15
CSRE 1A227(#)TR	E	220	22	8	0.15
CSRE 1A337(#)TR	E	330	33	8	0.15
16 volt @ 85°C (10 volt, @125°C)					
CSRA 1C105(#)TR	A	1.0	0.5	6	6.0
CSRA 1C155(#)TR	A	1.5	0.5	6	6.0
CSRS 1C225(#)TR	S	2.2	0.5	6	20.0
CSRA 1C225(#)TR	A	2.2	0.5	6	4.0
CSRA 1C335(#)TR	A	3.3	0.52	6	4.0
CSRB 1C335(#)TR	B	3.3	0.52	6	2.0
CSRA 1C475(#)TR	A	4.7	0.75	6	3.0
CSRB 1C475(#)TR	B	4.7	0.75	6	1.5
CSRA 1C685(#)TR	A	6.8	1.08	6	3.0
CSRB 1C685(#)TR	B	6.8	1.08	6	1.2
CSRC 1C685(#)TR	C	6.8	1.08	6	0.8
CSRB 1C106(#)TR	B	10	1.6	6	0.8
CSRC 1C106(#)TR	C	10	1.6	6	0.6
CSRB 1C156(#)TR	B	15	2.4	6	0.8
CSRC 1C156(#)TR	C	15	2.4	6	0.4
CSRC 1C226(#)TR	C	22	3.52	6	0.35
CSRD 1C226(#)TR	D	22	3.52	6	0.25
CSRC 1C336(#)TR	C	33	5.28	6	0.30
CSRD 1C336(#)TR	D	33	5.28	6	0.25
CSRC 1C476(#)TR	C	47	7.52	6	0.35
CSRD 1C476(#)TR	D	47	7.52	6	0.2
CSRD 1C686(#)TR	D	68	10.88	6	0.15
CSRD 1C107(#)TR	D	100	16	8	0.15
CSRE 1C107(#)TR	E	100	16	8	0.15
CSRE 1C157(#)TR	E	150	24	8	0.15

For 10% tolerance, insert, "K" in (#) above.
For 20% tolerance, insert, "M" in (#) above.

Series CSR

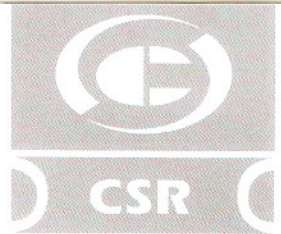

Solid Electrolytic Tantalum Chip Capacitors Surface Mount Low ESR Type

Ratings and Part Number Reference

Part No.	Case Size	Capacitance μ F	DCL (μ A) Max.	DF % Max.	ESR max. (Ω) @ 100kHz
20 volt @ 85°C (13 volt, @ 125°C)					
CSRA 1D684(#)TR	A	0.68	0.5	4	8.0
CSRA 1D105(#)TR	A	1.0	0.5	4	5.5
CSRA 1D155(#)TR	A	1.5	0.5	6	4.5
CSRA 1D225(#)TR	A	2.2	0.5	6	4.0
CSRB 1D225(#)TR	B	2.2	0.5	6	1.5
CSRA 1D335(#)TR	A	3.3	0.66	6	4.0
CSRB 1D335(#)TR	B	3.3	0.66	6	1.3
CSRA 1D475(#)TR	A	4.7	0.94	6	3.5
CSRB 1D475(#)TR	B	4.7	0.94	6	1.0
CSRC 1D475(#)TR	C	4.7	0.94	6	0.6
CSRB 1D685(#)TR	B	6.8	1.36	6	1.0
CSRC 1D685(#)TR	C	6.8	1.36	6	0.5
CSRB 1D106(#)TR	B	10	2.0	6	1.0
CSRC 1D106(#)TR	C	10	2.0	6	0.5
CSRC 1D156(#)TR	C	15	3.0	6	0.4
CSRD 1D156(#)TR	D	15	3.0	6	0.35
CSRC 1D226(#)TR	C	22	4.4	6	0.4
CSRD 1D226(#)TR	D	22	4.4	6	0.30
CSRC 1D336(#)TR	C	33	6.6	6	0.4
CSRD 1D336(#)TR	D	33	6.6	6	0.25
CSRD 1D476(#)TR	D	47	9.4	6	0.20
CSRD 1D686(#)TR	D	68	13.6	6	0.2
CSRE 1D686(#)TR	E	68	13.6	6	0.2
CSRE 1D107(#)TR	E	100	20	8	0.15
25 volt @ 85°C (16 volt, @ 125°C)					
CSRA 1E334(#)TR	A	0.33	0.5	4	10.0
CSRA 1E474(#)TR	A	0.47	0.5	4	9.0
CSRA 1E684(#)TR	A	0.68	0.5	4	6.0
CSRA 1E105(#)TR	A	1.0	0.5	4	4.0
CSRB 1E105(#)TR	B	1.0	0.5	4	2.0
CSRA 1E155(#)TR	A	1.5	0.55	6	5.0
CSRB 1E155(#)TR	B	1.5	0.82	6	1.5
CSRB 1E225(#)TR	B	2.2	0.82	6	2.2
CSRC 1E225(#)TR	C	2.2	0.82	6	1.2
CSRB 1E335(#)TR	B	3.3	1.17	6	2.0
CSRC 1E335(#)TR	C	3.3	1.7	6	1.2
CSRB 1E475(#)TR	B	4.7	1.7	6	1.0
CSRC 1E475(#)TR	C	4.7	1.7	6	0.6
CSRC 1E685(#)TR	C	6.8	2.5	6	0.6
CSRC 1E106(#)TR	C	10	2.5	6	0.6
CSRD 1E106(#)TR	D	10	3.75	6	0.4
CSRC 1E156(#)TR	C	15	3.75	6	0.4
CSRD 1E156(#)TR	D	15	5.5	6	0.9
CSRD 1E226(#)TR	D	22	8.25	6	0.4
CSRD 1E336(#)TR	D	33	8.25	6	0.4
CSRE 1E336(#)TR	E	33	8.25	6	0.3
CSRE 1E476(#)TR	E	47	11.8	6	0.3

Part No.	Case Size	Capacitance μ F	DCL (μ A) Max.	DF % Max.	ESR max. (Ω) @ 100kHz
35 volt @ 85°C (22 volt, @ 125°C)					
CSRA 1V104(#)TR	A	0.1	0.5	4	10.0
CSRA 1V154(#)TR	A	0.15	0.5	4	6.0
CSRA 1V224(#)TR	A	0.22	0.5	4	6.0
CSRA 1V334(#)TR	A	0.33	0.5	4	6.0
CSRA 1V474(#)TR	A	0.47	0.5	4	4.0
CSRB 1V474(#)TR	B	0.47	0.5	4	2.5
CSRA 1V684(#)TR	A	0.68	0.5	4	6.0
CSRB 1V684(#)TR	B	0.68	0.5	4	2.5
CSRA 1V105(#)TR	A	1.0	0.5	4	6.0
CSRB 1V105(#)TR	B	1.0	0.5	4	2.0
CSRB 1V155(#)TR	B	1.5	0.5	6	3.0
CSRC 1V155(#)TR	C	1.5	0.52	6	2.5
CSRB 1V225(#)TR	B	2.2	0.77	6	2.5
CSRC 1V225(#)TR	C	2.2	0.77	6	1.5
CSRB 1V335(#)TR	B	3.3	1.15	6	2.0
CSRC 1V335(#)TR	C	3.3	1.15	6	0.8
CSRC 1V475(#)TR	C	4.7	1.64	6	0.7
CSRD 1V475(#)TR	D	4.7	1.64	6	0.7
CSRC 1V685(#)TR	C	6.8	2.38	6	0.9
CSRD 1V685(#)TR	D	6.8	2.38	6	0.5
CSRC 1V106(#)TR	C	10	3.50	6	1.2
CSRD 1V106(#)TR	D	10	3.50	6	0.4
CSRD 1V156(#)TR	D	15	5.25	6	0.35
CSRE 1V156(#)TR	E	15	5.25	6	0.3
CSRD 1V226(#)TR	D	22	7.70	6	0.4
CSRE 1V226(#)TR	E	22	7.70	6	0.3
50 volt @ 85°C (32 volt, @ 125°C)					
CSRA 1H104(#)TR	A	0.1	0.5	4	10.0
CSRA 1H154(#)TR	A	0.15	0.5	4	10.0
CSRB 1H154(#)TR	B	0.15	0.5	4	10.0
CSRB 1H224(#)TR	B	0.22	0.5	4	10.0
CSRB 1H334(#)TR	B	0.33	0.5	4	2.5
CSRB 1H474(#)TR	B	0.47	0.5	4	2.0
CSRC 1H474(#)TR	C	0.47	0.5	4	1.8
CSRB 1H684(#)TR	B	0.68	0.5	4	3.0
CSRC 1H684(#)TR	C	0.68	0.5	4	1.6
CSRC 1H105(#)TR	C	1.0	0.5	4	1.6
CSRC 1H155(#)TR	C	1.5	0.75	6	1.5
CSRD 1H155(#)TR	D	1.5	0.75	6	1.0
CSRC 1H225(#)TR	C	2.2	1.1	6	1.5
CSRD 1H225(#)TR	D	2.2	1.1	6	0.8
CSRD 1H335(#)TR	D	3.3	1.65	6	0.8
CSRD 1H475(#)TR	D	4.7	2.35	6	0.6
CSRE 1H685(#)TR	E	6.8	3.4	6	0.5

All technical data relates to an ambient temperature of +20°C measured at 120 Hz, 0.5V RMS unless otherwise stated.

Insert tolerance, K for $\pm 10\%$ and M for $\pm 20\%$.

Series CSR

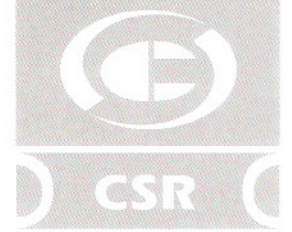

Solid Electrolytic Tantalum Chip Capacitors Surface Mount Low ESR Type

Carrier Tape Packaging Specification Explanation Of Part Numbers

C S R
Series Code
A
Case Size
O G
Rated Voltage
4 7 5
Nominal Capacitance
M
Capacitance Tolerance
T
Carrier Tape Packaging
R
Polarity Orientation

Dimensions of the carrier tape and standard parts quantity per reel.

Dimensions

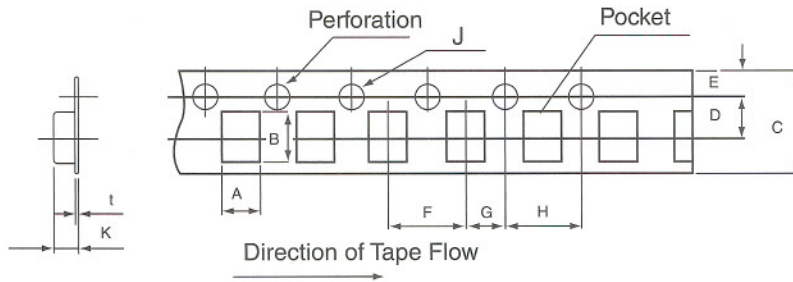

(Unit:mm)

CASE SIZE	A ±0.1	B ±0.1	C ±0.3	D ±0.1	E ±0.1	F ±0.1	G ±0.1	H ±0.1	J +0.1 -0	K MAX	t	Quantity Per Reel
S	1.6	2.4	8.0	3.5	1.75	4.0	2.0	4.0	1.5	2.5	0.2	2500
A	1.9	3.5	8.0	3.5	1.75	4.0	2.0	4.0	1.5	2.5	0.2	2000
B	3.1	3.8	8.0	3.5	1.75	4.0	2.0	4.0	1.5	2.5	0.2	2000
C	3.6	6.4	12.0	5.5	1.75	8.0	2.0	4.0	1.5	3.0	0.3	500
D	4.7	7.7	12.0	5.5	1.75	8.0	2.0	4.0	1.5	3.4	0.3	500
E	4.6	7.6	12.0	5.5	1.75	8.0	2.0	4.0	1.5	4.6	0.3	500

Inserting Direction (Polarity Orientation)

Polarity L: To be inserted with the positive side to the feed hole.

Polarity R: To be inserted with the negative side to the feed hole.

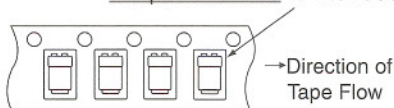

Reel Dimensions

(Unit:mm)

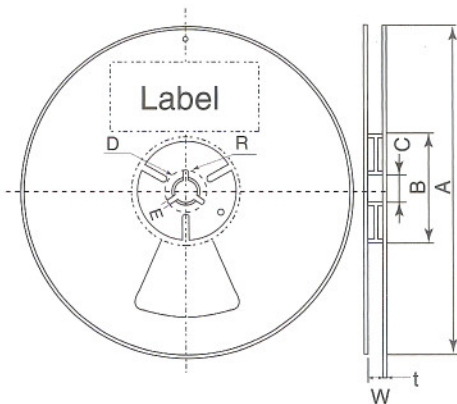

Tape width	8	12
A ₃ ⁰	∅ 180	←
B ₀ ⁺¹	∅ 60	←
C ± 0.2	∅ 13	←
D ± 0.8	∅ 21	←
E ± 0.5	2.0	←
W ± 0.3	9.0	13.0
t ± 0.4	1.3	←
R ± 0.4	10.5	←

Tape Leader and Tailer

